

Digital Photo Frame

DPF-V900/V700

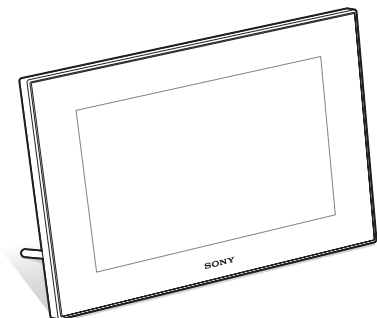

Before operation

Basic operations

Advanced operations

Using an external device

Error messages

Troubleshooting

Additional information

Operating Instructions

Before operating this unit, please read this manual thoroughly and retain it for future reference.

Owner's Record

The model and serial numbers are located at the rear.
Record the serial number in the space provided below. Refer to these numbers whenever you call upon your Sony dealer regarding this product.

Model No. DPF-V900/V700

Serial No. _____



WARNING

To reduce fire or shock hazard, do not expose the unit to rain or moisture.

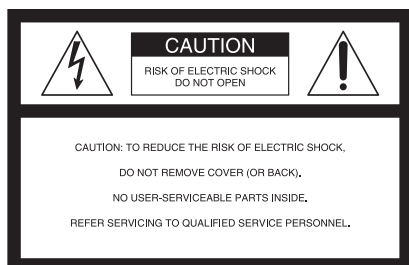

This symbol is intended to alert the user to the presence of uninsulated “dangerous voltage” within the product’s enclosure that may be of sufficient magnitude to constitute a risk of electric shock to persons.



This symbol is intended to alert the user to the presence of important operating and maintenance (servicing) instructions in the literature accompanying the appliance.

IMPORTANT SAFEGUARDS

For your protection, please read these safety instructions completely before operating the appliance, and keep this manual for future reference. Carefully observe all warnings, precautions and instructions on the appliance, or the one described in the operating instructions and adhere to them.

Use

Power Sources

This set should be operated only from the type of power source indicated on the marking label. If you are not sure of the type of electrical power supplied to your home, consult your dealer or local power company. For those sets designed to operate from battery power, or other sources, refer to the operating instructions.

Polarization

This set may be equipped with a polarized ac power cord plug (a plug having one blade wider than the other).

This plug will fit into the power outlet only one way. This is a safety feature. If you are unable to insert the plug fully into the outlet, try reversing the plug. If the plug should still fail to fit, contact your electrician to have a suitable outlet installed. Do not defeat the safety purpose of the polarized plug by forcing it in.

Overloading

Do not overload wall outlets, extension cords or convenience receptacles beyond their capacity, since this can result in fire or electric shock.

Object and Liquid Entry

Never push objects of any kind into the set through openings as they may touch dangerous voltage points or short out parts that could result in a fire or electric shock. Never spill liquid of any kind on the set.

Attachments

Do not use attachments not recommended by the manufacturer, as they may cause hazards.

Cleaning

Unplug the set from the wall outlet before cleaning or polishing it. Do not use liquid cleaners or aerosol cleaners. Use a cloth lightly dampened with water for cleaning the exterior of the set.

Installation

Water and Moisture

Do not use power-line operated sets near water – for example, near a bathtub, washbowl, kitchen sink, or laundry tub, in a wet basement, or near a swimming pool, etc.

Power-Cord Protection

Route the power cord so that it is not likely to be walked on or pinched by items placed upon or against them, paying particular attention to the plugs, receptacles, and the point where the cord exits from the appliance.

Accessories

Do not place the set on an unstable cart, stand, tripod, bracket, or table. The set may fall, causing serious injury to a child or an adult, and serious damage to the set. Use only a cart, stand, tripod, bracket, or table recommended by the manufacturer.

Ventilation

The slots and openings in the cabinet are provided for necessary ventilation. To ensure reliable operation of the set, and to protect it from overheating, these slots and openings must never be blocked or covered.

- Never cover the slots and openings with a cloth or other materials.
- Never block the slots and openings by placing the set on a bed, sofa, rug, or other similar surface.
- Never place the set in a confined space, such as a bookcase, or built-in cabinet, unless proper ventilation is provided.
- Do not place the set near or over a radiator or heat register, or where it is exposed to direct sunlight.

Lightning

For added protection for this set during a lightning storm, or when it is left unattended and unused for long periods of time, unplug it from the wall outlet and disconnect the antenna or cable system. This will prevent damage to the set due to lightning and power-line surges.

Service

Damage Requiring Service

Unplug the set from the wall outlet and refer servicing to qualified service personnel under the following conditions:

- When the power cord or plug is damaged or frayed.
- If liquid has been spilled or objects have fallen into the set.
- If the set has been exposed to rain or water.
- If the set has been subject to excessive shock by being dropped, or the cabinet has been damaged.

- If the set does not operate normally when following the operating instructions. Adjust only those controls that are specified in the operating instructions. Improper adjustment of other controls may result in damage and will often require extensive work by a qualified technician to restore the set to normal operation.
- When the set exhibits a distinct change in performance – this indicates a need for service.

Servicing

Do not attempt to service the set yourself as opening or removing covers may expose you to dangerous voltage or other hazards.

Refer all servicing to qualified service personnel.

Replacement parts

When replacement parts are required, be sure the service technician has used replacement parts specified by the manufacturer that have the same characteristics as the original parts.

Unauthorized substitutions may result in fire, electric shock, or other hazards.

Safety Check

Upon completion of any service or repairs to the set, ask the service technician to perform routine safety checks (as specified by the manufacturer) to determine that the set is in safe operating condition.

WARNING

Do not expose the batteries to excessive heat such as sunshine, fire or the like.

CAUTION

Replace the battery with the specified type only. Otherwise, fire or injury may result.

For the customers in the U.S.A.

CAUTION

You are cautioned that any changes or modifications not expressly approved in this manual could void your authority to operate this equipment.

If you have any questions about this product, you may call:

*Sony Customer Information Services Center
1-800-222-SONY (7669)*

The number below is for the FCC related matters only.

Regulatory Information

Declaration of Conformity

Trade Name: SONY
Model No.: DPF-V900
Responsible Party: Sony Electronics Inc.
Address: 16530 Via Esprillo, San Diego,
CA 92127 U.S.A.
Telephone No.: 858-942-2230

This device complies with part 15 of the FCC Rules. Operation is subject to the following two conditions:

(1) This device may not cause harmful interference, and (2) this device must accept any interference received, including interference that may cause undesired operation.

Declaration of Conformity

Trade Name: SONY
Model No.: DPF-V700
Responsible Party: Sony Electronics Inc.
Address: 16530 Via Esprillo, San Diego,
CA 92127 U.S.A.
Telephone No.: 858-942-2230

This device complies with part 15 of the FCC Rules. Operation is subject to the following two conditions:

(1) This device may not cause harmful interference, and (2) this device must accept any interference received, including interference that may cause undesired operation.

For the State of California, USA only

Perchlorate Material - special handling may apply, See

www.dtsc.ca.gov/hazardouswaste/perchlorate

Perchlorate Material: Lithium battery contains perchlorate.

Note:

This equipment has been tested and found to comply with the limits for a Class B digital device, pursuant to Part 15 of the FCC Rules.

These limits are designed to provide reasonable protection against harmful interference in a residential installation. This equipment generates, uses, and can radiate radio frequency energy and, if not installed and used in accordance with the instructions, may cause harmful interference to radio communications. However, there is no guarantee that interference will not occur in a particular installation. If this equipment does cause harmful interference to radio or television reception, which can be determined by turning the equipment off and on, the user is encouraged to try to correct the interference by one or more of the following measures:

- Reorient or relocate the receiving antenna.
- Increase the separation between the equipment and receiver.
- Connect the equipment into an outlet on a circuit different from that to which the receiver is connected.
- Consult the dealer or an experienced radio/TV technician for help.

“Lamp in this product contains mercury. Disposal of these materials may be regulated due to environmental considerations. For disposal or recycling information, please contact your local authorities or the Electronic Industries Alliance (www.eiae.org).”

For the Customer in Europe

This product has been tested and found compliant with the limits set out in the EMC Directive for using connection cables shorter than 3 meters (9.8 feet).

Attention

The electromagnetic fields at the specific frequencies may influence the picture of this digital photo frame.

Notice

If static electricity or electromagnetism causes data transfer to discontinue midway (fail), restart the application or disconnect and connect the communication cable (USB, etc) again.

Disposal of Old Electrical & Electronic Equipment (Applicable in the European Union and other European countries with separate collection systems)



This symbol on the product or on its packaging indicates that this product shall not be treated as household waste. Instead it shall be handed over to the applicable collection point for the recycling of electrical and electronic equipment. By ensuring this product is disposed of correctly, you will help prevent potential negative consequences for

the environment and human health, which could otherwise be caused by inappropriate waste handling of this product. The recycling of materials will help to conserve natural resources. For more detailed information about recycling of this product, please contact your local Civic Office, your household waste disposal service or the shop where you purchased the product.

Disposal of waste batteries (applicable in the European Union and other European countries with separate collection systems)



This symbol on the battery or on the packaging indicates that the battery provided with this product shall not be treated as household waste. By ensuring these batteries are disposed of correctly, you will help prevent potentially negative consequences for

the environment and human health which could otherwise be caused by inappropriate waste handling of the battery. The recycling of the materials will help to conserve natural resources. In case of products that for safety, performance or data integrity reasons

require a permanent connection with an incorporated battery, this battery should be replaced by qualified service staff only. To ensure that the battery will be treated properly, hand over the product at end-of-life to the applicable collection point for the recycling of electrical and electronic equipment. For all other batteries, please view the section on how to remove the battery from the product safely. Hand the battery over to the applicable collection point for the recycling of waste batteries.

For more detailed information about recycling of this product or battery, please contact your local Civic Office, your household waste disposal service or the shop where you purchased the product.

Notice for the customers in the countries applying EU Directives

The manufacturer of this product is Sony Corporation, 1-7-1 Konan Minato-ku Tokyo, 108-0075 Japan. The Authorized Representative for EMC and product safety is Sony Deutschland GmbH, Hedelfinger Strasse 61, 70327 Stuttgart, Germany. For any service or guarantee matters please refer to the addresses given in separate service or guarantee documents.

NOTICE FOR CUSTOMERS IN THE UNITED KINGDOM

A moulded plug complying with BS 1363 is fitted to this equipment for your safety and convenience.

Should the fuse in the plug supplied need to be replaced, a fuse of the same rating as the supplied one and approved by ASTA or BSI to BS 1362, (i.e. marked with ⚡ or ⚡ mark) must be used.

If the plug supplied with this equipment has a detachable fuse cover, be sure to attach the fuse cover after you change the fuse. Never use the plug without the fuse cover. If you should lose the fuse cover, please contact your nearest Sony service station.

Duplication, edition, or printing of a CD, TV programs, copyrighted materials such as pictures or publications, or any other materials except for your own recording or creation is limited to private or domestic use only. Unless you hold copyright or have permission of copyright holders for the materials to be duplicated, use of those materials beyond this limit may infringe the provisions of the copyright law and be subject to the copyright holders claim for damages.

When using photo images with this digital photo frame, pay special attention not to infringe the provisions of the copyright law. Any unauthorized use or modification of there's portrait may also infringe their rights.

For some demonstrations, performances, or exhibits, photography may be forbidden.

Backup recommendations

To avoid potential risk of data loss caused by accidental operation or malfunction of the digital photo frame, we recommend that you save a backup copy of your data.

Information

IN NO EVENT SHALL SELLER BE LIABLE FOR ANY DIRECT, INCIDENTAL OR CONSEQUENTIAL DAMAGES OF ANY NATURE, OR LOSSES OR EXPENSES RESULTING FROM ANY DEFECTIVE PRODUCT OR THE USE OF ANY PRODUCT.



Sony shall assume no responsibility for any accidental or consequential damages or loss of the recording contents which may be caused by use or malfunction of the digital photo frame or memory card.

Notes on LCD screen

- The displayed image on the screen is not identical in picture quality and colors with the printed image because phosphor methods or profiles differ. Please regard the displayed image as just a reference.
- Do not press against the LCD screen. The screen may be discolored and that may cause a malfunction.
- Exposing the LCD screen to direct sunlight for long periods may cause malfunctions.
- The LCD screen is manufactured using extremely high-precision technology, so over 99.99% of the pixels are operational for effective use. However, there may be some tiny black points and/or bright points (white, red, blue or green in color) that constantly appear on the LCD screen. These points are normal in the manufacturing process and do not affect the printing in any way.
- Images may trail across on the LCD screen in a cold location. This is not a malfunction.

On trademarks and copyrights

- **S-Frame**, BRAVIA, BRAVIA Sync, , "PhotoTV HD", , Cyber-shot, , "Memory Stick", **MEMORY STICK**, "Memory Stick Duo", **MEMORY STICK DUO**, "MagicGate Memory Stick", "Memory Stick PRO", **MEMORY STICK PRO**, "Memory Stick PRO Duo", **MEMORY STICK PRO DUO**, "Memory Stick PRO-HG Duo", **MEMORY STICK PRO-HG DUO**, "Memory Stick Micro", **MEMORY STICK MICRO**, **M2**, "Memory Stick-ROM", **MEMORY STICK-ROM**, "MagicGate", and **MAGICGATE** are trademarks or registered trademarks of Sony Corporation.

- HDMI, **HDMI**, and High-Definition Multimedia Interface are trademarks or registered trademarks of HDMI Licensing LLC.
- Microsoft, Windows, and Windows Vista are either registered trademarks or trademarks of Microsoft Corporation in the United States and/or other countries.
- Macintosh and Mac OS are registered trademarks of Apple Inc. in the United States and/or other countries.
- Intel and Pentium are the registered trademarks or trademarks of Intel Corporation.
- CompactFlash is a trademark of SanDisk Corporation in the U.S.A.
-  or xD-Picture Card™ is a trademark of FUJIFILM Corporation.
-  is a trademark of FotoNation Inc. in the U.S.A.
- **SILKYPIX**® is a trademark of Ichikawa Soft Laboratory.
- Contains bitmap fonts from Monotype Imaging Inc.
- All other companies and product names mentioned herein may be the trademarks or registered trademarks of their respective companies. Furthermore, "TM" and "®" are not mentioned in each case in this manual.
- This unit is equipped with face recognition feature. Sony Face Recognition technology developed by Sony is used.
- The Bluetooth word mark and logos are owned by the Bluetooth SIG, Inc. and any use of such marks by Sony Corporation is under licence. Other trademarks and trade names are those of their respective owners.

Notice for users

Program © 2008 Sony Corporation
Documentation © 2008 Sony Corporation

All rights reserved. This manual or the software described herein, in whole or in part, may not be reproduced, translated or reduced to any machine readable form without prior written approval from Sony Corporation.

IN NO EVENT SHALL SONY CORPORATION BE LIABLE FOR ANY INCIDENTAL, CONSEQUENTIAL OR SPECIAL DAMAGES, WHETHER BASED ON TORT, CONTACT, OR OTHERWISE, ARISING OUT OF OR IN CONNECTION WITH THIS MANUAL, THE SOFTWARE OR OTHER INFORMATION CONTAINED HEREIN OR THE USE THEREOF.

By breaking the seal of the envelope of the CD-ROM package, you accept all the terms and conditions of this agreement. If you do not accept these terms and conditions, please return this disk envelope unopened, along with the rest of the package, immediately to the dealer where you obtained it.

Sony Corporation reserves the right to make any modification to this manual or the information contained herein at any time without notice. The software described herein may also be governed by the terms of a separate user license agreement.

Any design data such as sample pictures provided in this software cannot be modified or duplicated except for the purpose of personal use. Any unauthorized duplication of this software is prohibited under copyright law.

Please note that unauthorized duplication or modification of portraits or copyrighted work could infringe the rights reserved by rights holders.

On the illustrations and screen shots used in this manual

The illustrations and screen shots used in this manual are of the DPF-V900 unless noted otherwise.

Table of Contents

Before operation

Enjoy your photo frame in various ways	10
Features	12
Checking included items	13
Identifying the parts	13

Basic operations

Preparing the remote control	16
Connecting to the AC power source	17
Setting the stand	18
Turning the photo frame on	19
Setting the clock	19
Inserting a memory card and viewing images	20
Inserting a memory card	20
Displaying images	22

Advanced operations

AUTO TOUCH-UP	27
Specifying the playback device	28
Adjusting the image size and position	28
Enlarging an image	28
Rotating an image	28
Adding to the internal memory	29
Exporting an image	31

Deleting an image	32
Changing the various settings	33
Setting procedure	33
Items to set	34
Connecting to a high definition TV to view images	36
Connecting to a high definition TV	36

Using an external device

Using a Bluetooth device	38
Transferring images from an external device	38
Connecting to a computer	39
System requirements	39
Connecting to a computer to exchange images	40

Error messages

If an error message appears	41
-----------------------------------	----

Troubleshooting

If trouble occurs	43
-------------------------	----

Additional information

Precautions	47
On safety	47
On installation	47
On cleaning	47
On restrictions on duplication	48

About the memory cards48
 “Memory Stick”48
 SD memory card49
 xD-Picture Card50
 CompactFlash card50
 Notes on using a memory card50
Specifications51
Index53

Enjoy your photo frame in various ways

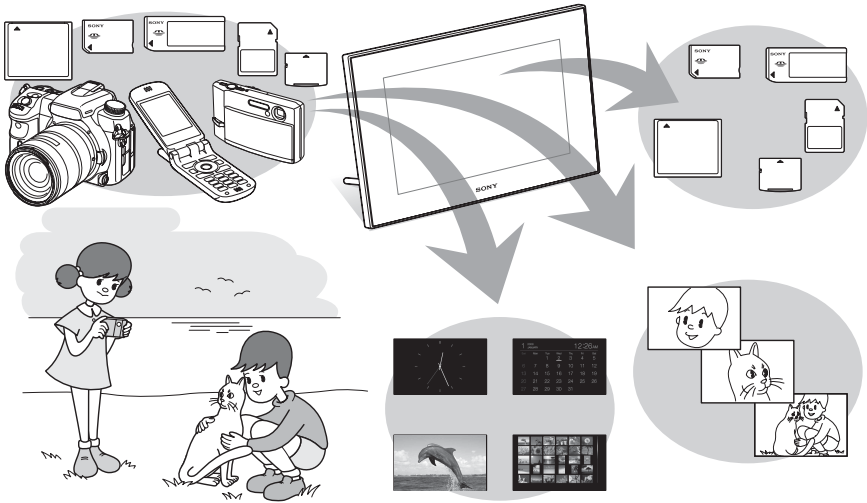

Easy display of images in a memory card or external device such as a digital camera

Various display functions

In addition to slideshows, you can enjoy various display modes easily including the single image, index, clock, and calendar modes. (→ page 22)

Adding important images to an album (saving to the internal memory)

Images added to the album are saved in the internal memory. You can also export these images to a memory card or external device.

Input to the photo frame

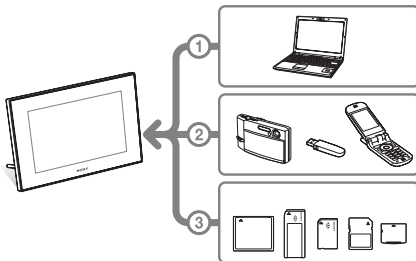

As shown on the left, the photo frame gives priority in order of computer, external device, and memory card if computer and memory cards are connected/inserted to the photo frame. If multiple memory cards are inserted, the images of the memory card you inserted first are displayed.

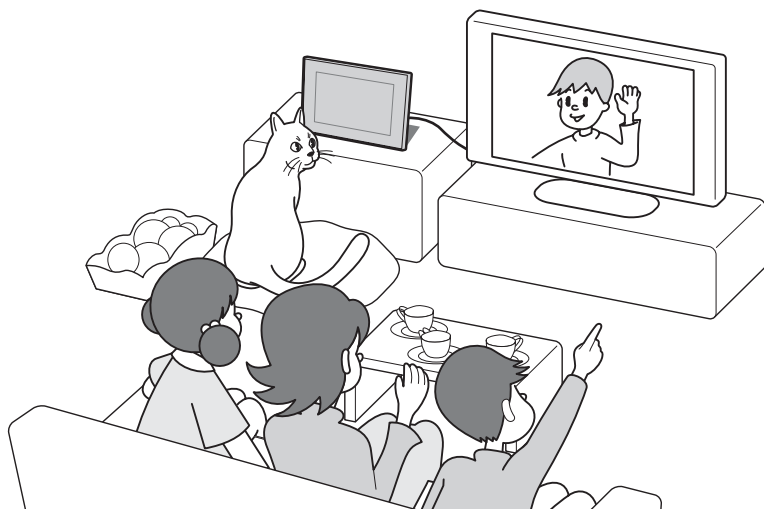

Enjoying images on a large TV screen

If you connect the photo frame to a TV with an HDMI cable, you can enjoy slideshows and single image display on a large screen.

Various devices you can use

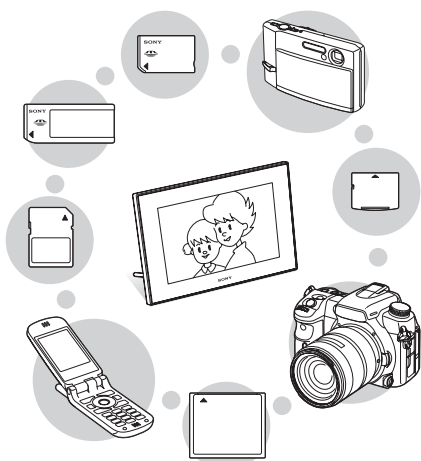

Connecting to your computer

Images can be copied from a computer easily. You can also save images in the album to a computer as a backup. Images can also be exchanged with a memory card, USB memory, etc. and copied from a Bluetooth compatible device.

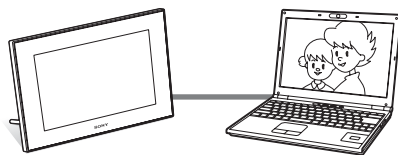

Features

The Sony DPF-V900/V700 is a digital photo frame for easily displaying images taken with a digital camera or other device without using a computer.

■ Support for various memory cards

Supports various memory cards used by digital cameras and other devices, such as a “Memory Stick”, CompactFlash card, SD memory card, and xD-Picture Card™. Just insert a memory card removed from a digital camera or other device, then you will be able to view the images immediately.

■ Easy transfer of images taken with a Bluetooth compatible mobile phone or other device

You can transfer images to the photo frame’s internal memory from a Bluetooth compatible device via a Bluetooth adaptor (optional).

■ Support for mass storage compatible devices

■ Connecting to a high definition TV to display images on a large screen

Using the photo frame’s HDMI output connector, you can enjoy the images in a memory card, external device, or internal memory on a large screen.

■ Various modes

The displayed image can be switched automatically as though you are turning the pages of an album yourself. You can select from various modes including just images, clock, and calendar view. You can also change playback settings such as the display order.

■ Various display functions

You can enjoy various view modes, such as displaying an analog clock, digital clock or calendar. And the photo frame can display images on single image display, index image display, zoom in/zoom out or fit to screen mode.

■ Automatic rotation of images

The photo frame automatically rotates images to their proper orientation. Images are also automatically rotated when the photo frame is set in either the portrait or landscape position.

■ Easy operation by remote control

■ Adding images to internal memory

The images you add to the album are saved to internal memory.

■ Exporting images

You can export images in the album to your memory card.

■ AUTO TOUCH-UP features

You can enjoy beautiful images by automatic corrections of backlight, focus, red-eye, and skin smoothing.

■ Connecting to a computer to exchange the images

Checking included items

Make sure that the following items are included.

- Digital photo frame (1)
- Remote control (1)
- AC adaptor (1)
- AC power cord (1)
- Operating Instructions (this manual) (1)
- Warranty (1)

(In some regions, the warranty is not supplied.)

Identifying the parts

For details, see the pages indicated in the parentheses.

The illustrations and names of buttons and connectors of the DPF-V700 are identical to those of the DPF-V900, although the LCD screen size is different.

Front

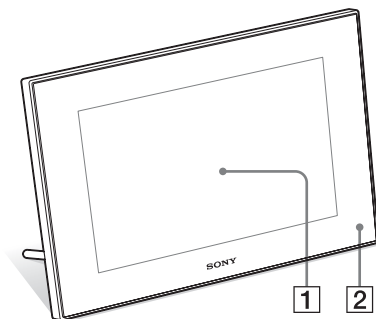

1 LCD screen

2 Remote sensor

When using the supplied remote control, point it at this sensor.

Rear

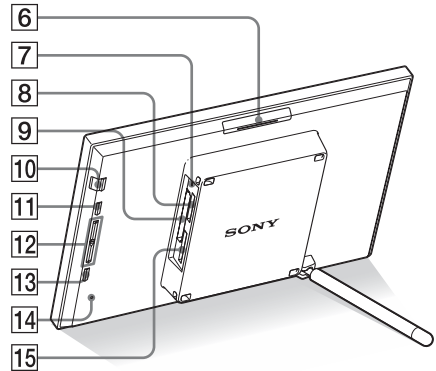
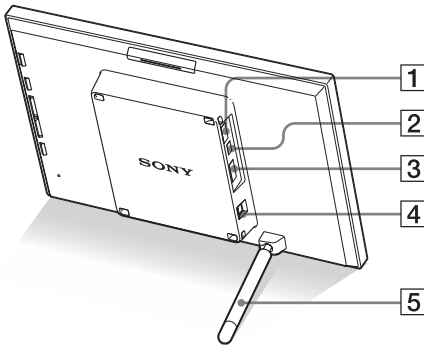

1 Connector for Ψ USB A/Bluetooth adaptor (→ page 38)

You can transfer images wirelessly from a BLUETOOTH™ compatible mobile phone or digital camera by connecting a Bluetooth adaptor (optional: DPPA-BT1).

You can also connect a digital camera, USB memory, or photo storage compatible with USB mass storage.

2 Ψ USB miniB connector (→ page 40)

Connect a USB cable when you want to use the photo frame with a computer.

3 HDMI OUT (output) connector (→ page 36)

Connect an HDMI cable when you want to view images on a high definition TV.

4 DC IN 8.4 V jack (→ page 17)

Insert the plug of the supplied AC adaptor to this jack, and connect the AC power cord to the AC adaptor and the wall outlet.

5 Stand (→ page 18)

6 VIEW MODE button

7 Access lamp (→ page 20)

8 "Memory Stick PRO" (Standard/Duo) slot (→ page 20)

9 CompactFlash card/Microdrive slot (→ page 20)

10 ⏻ (on/standby) button/(standby) indicator

11 MENU button

Displays the menu.

You can use the menu to operate same functions of buttons on remote control such as [Slideshow], [Rotate], [Add to album] and [Clock] from the menu.

12 Direction (\updownarrow) buttons

These buttons move the cursor.

13 ↵ ENTER button

14 Reset switch

15 SD memory card/MMC/xD-Picture Card slot (→ page 20)

Remote control

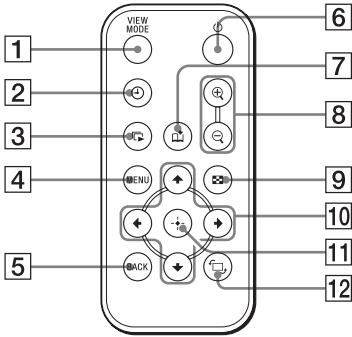

- 1 VIEW MODE button**
- 2 ⌚ (clock) button**
- 3 🖼️ (slideshow) button**
- 4 MENU button**
- 5 BACK button**
- 6 ⏻ (on/standby) button**
- 7 📁 (add to album) button**
- 8 🔍 (zoom in)/🔍 (zoom out) buttons**
- 9 🗪 (index) button**
This button switches from the image preview screen to index view screen.
- 10 Direction (←/→/↑/↓) buttons**
- 11 ↵ (enter) button**
- 12 🔄 (rotation) button (→ page 28)**

Preparing the remote control

The supplied lithium battery (CR2025) has already been inserted into the remote control. Pull out the protective sheet before use as shown in the figure.

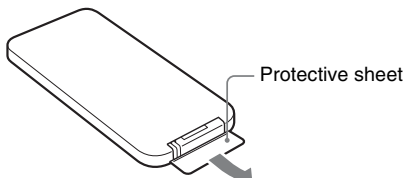

Using the remote control

Point the top end of the remote control towards the remote sensor on the photo frame.

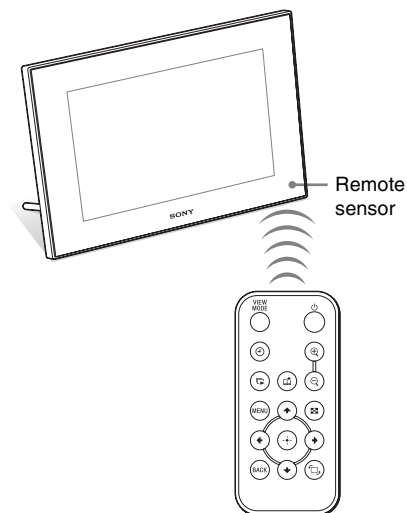

Replacing the battery of the remote control

If the remote control stops working, replace the battery (CR2025 lithium battery) with a new one.

- 1** Pull out the battery holder. While pressing in the tab of the battery holder, pull out the battery holder.

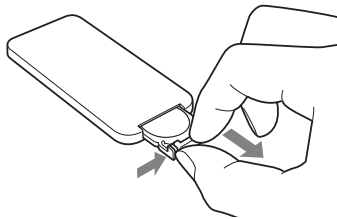

- 2** Remove the old battery from the battery holder and then insert a new battery. Insert the battery so that "+" is facing upwards.

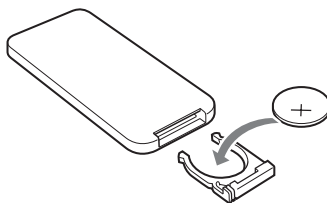

- 3** Reinsert the battery holder into the remote control.

WARNING

Battery may explode if mistreated. Do not recharge, disassemble or dispose of in fire.

Notes

- When the lithium battery becomes weak, the operating distance of the Remote control may shorten, or the Remote control may not function properly. In this case, replace the battery with a Sony CR2025 lithium battery. Use of another battery may present a risk of fire or explosion.

- Using a battery other than the specified one may result in the battery rupturing.
- Dispose of used batteries as specified by the local authorities.
- Do not leave the remote control in a very hot and humid place.
- Take care that no foreign objects enter inside the remote control when you, for example, replace the battery.
- Incorrect use of the battery may cause leaking and corrosion.
 - Do not recharge the battery.
 - When the remote control will not be used for a long period of time, remove the battery from the remote control to prevent leaking and corrosion.
 - Incorrectly inserting, shorting, dismantling, or heating the battery, or throwing it into a fire may cause the battery to rupture and leak.

About descriptions in this manual

The operations described in this manual are based on remote control operation. When an operation is performed differently with the remote control and buttons on photo frame, it will be explained in a tip.

Connecting to the AC power source

- 1 Insert the plug of the AC adaptor into the DC IN 8.4 V jack on the rear of the photo frame.
- 2 Connect the AC power cord to the AC adaptor and the wall outlet.

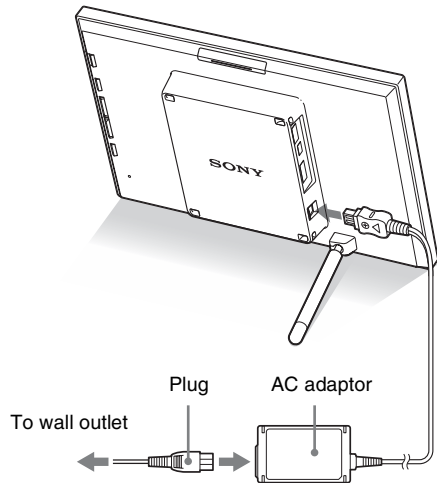

Notes

- A socket outlet should be as close as possible to unit and easily accessible.
- Do not place the photo frame in an unsteady location such as on an uneven table or tilted surface.
- Connect the AC adaptor to an easily accessible wall outlet close by. If trouble occurs while using the adaptor, immediately shut off the power by disconnecting the plug from the wall outlet.
- Do not short the plug of the AC adaptor with a metal object. Doing so may cause a malfunction.
- Do not use the AC Adaptor placed in a narrow space, such as between a wall and furniture.
- After use, remove the AC adaptor from the DC IN 8.4 V jack of the photo frame, and remove the AC power cord from the outlet.

Continued

To use your photo frame abroad - Power sources

You can use your photo frame and the AC Adaptor (supplied) in any country or region where the power supply is within 100 V to 240 V AC, 50/60 Hz. Use a commercially available AC plug adaptor [a], if necessary, depending on the wall outlet (wall socket) [b].

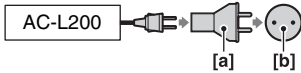

Do not use an electronics transformer (travel converter), as this may cause a malfunction.

Setting the stand

Opening the stand

Set the photo frame with opening the stand as below.

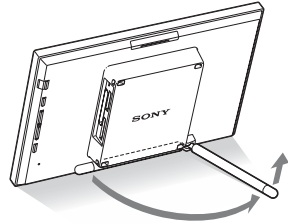

Setting to portrait or landscape orientation

You can set the photo frame to portrait or landscape orientation by rotating it without moving the stand.

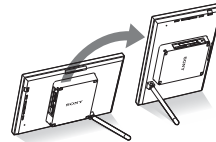

When the photo frame is placed in the portrait orientation, the image is also automatically rotated to its proper orientation.

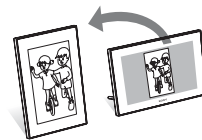

Notes

- Close the stand when you carry the photo frame.
- Check whether the stand is stable. If the stand is not set properly, the photo frame may fall over.
- When the photo frame is rotated to the portrait orientation, the menu, image information and index display are not rotated.

Turning the photo frame on

Turning on the power

Press ⏻ (on/standby) on the photo frame or remote control to turn on the power, and the standby indicator turns into green from red.

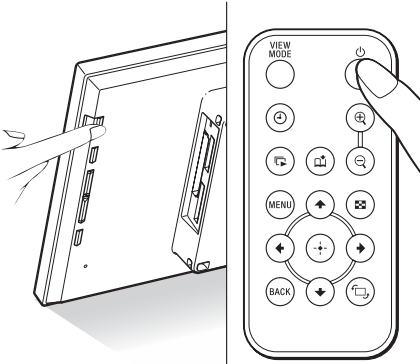

Note

- The standby indicator lights red, when you connect the AC adaptor to the photo frame.

Turning off the power

Hold ⏻ (on/standby) on the photo frame or remote control until turning off the power. The standby indicator turns into red from green.

Note

- Do not disconnect the AC adaptor from the photo frame before the standby indicator turns into red. Doing so may damage the photo frame.

Setting the clock

The clock of the photo frame needs to be adjusted in order to display an accurate time in the clock and calendar view modes.

When you power on the first time after purchase, demo mode will automatically start. During demo mode, you cannot set up clock.

Please insert memory card with valid picture data which will disable demo mode. After disabling demo mode, you can start clock setting.

- 1 Press MENU on the remote control. The menu screen is displayed.
- 2 Press ⏴ / ⏵ to select [Various settings] and then press ⊕ to display the Various settings screen.
- 3 Press ⏴ / ⏵ to select [Date/time settings] and then press ⊕ . The Date/time settings screen is displayed.

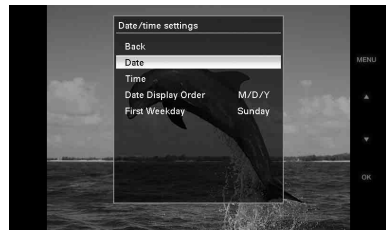

- 4 Select the format of the date.
 - ① Press ⏴ / ⏵ to select [Date Display Order] and then press ⊕ .
 - ② Press ⏴ / ⏵ to select a format and then press ⊕ .
 - Y/M/D
 - M/D/Y
 - D/M/Y
- 5 Adjust the date.
 - ① Press ⏴ / ⏵ to select [Date] and then press ⊕ .

② Press $\blacktriangledown/\blacktriangle$ to select a value and then press \odot .

6 Adjust the time.

① Press $\blacktriangledown/\blacktriangle$ to select [Time] and then press \odot .

② Press $\blacktriangledown/\blacktriangle$ to select a value and then press \odot .

Set the time in the order of hour, minute, and second.

7 Set the day to start the week for the calendar.

You can set the day that appears on the very left when the calendar is displayed.

① Press $\blacktriangledown/\blacktriangle$ to select [First Weekday] and then press \odot .

② Press $\blacktriangledown/\blacktriangle$ to select [Sunday] or [Monday] and then press \odot .

8 Press MENU.

The menu screen is closed.

Inserting a memory card and viewing images

This section describes inserting a memory card and general operations for displaying images in a slideshow.

Inserting a memory card

Insert a memory card firmly into the corresponding slot with its label side facing toward you (when taking your position on the rear side of the photo frame).

For details on the memory cards you can use with this photo frame, see pages 48 to 50.

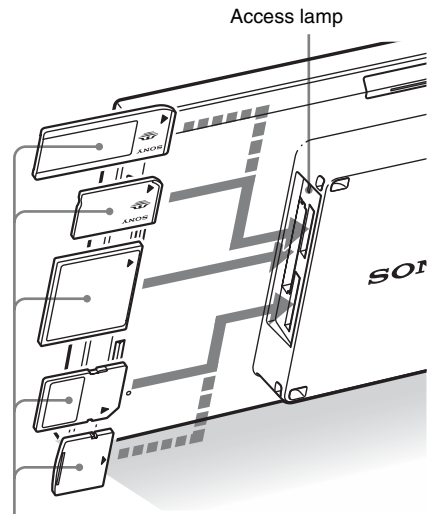

Insert a memory card firmly into the corresponding slot with its label side facing toward you. The slot order from the top is "Memory Stick" ("Memory Stick Duo"), CompactFlash card, SD memory card and xD-Picture Card.

To remove a memory card

Remove a memory card from a slot in the opposite direction from which it was inserted.

- When inserting the memory card, it will only insert the portion of the way, so do not try to force it as this could damage the memory card and/or photo frame.
- This photo frame has “Memory Stick” standard and Duo size compatible slot, so you do not need a Memory Stick adaptor.
- The SD memory card/xD-Picture Card dual-purpose slot automatically detects the card type.
- Before using a memory card, see “About the memory cards” on page 48.

Display priority of images

If a memory card is inserted or external device is connected, the images of the inserted memory card or connected device are displayed automatically. To manually change the memory card or external device to be displayed, specify it in the [Select device] menu (page 28).

The photo frame displays the images of the memory card in the following priorities.

- **If a device is connected to the USB A connector of the photo frame**, the images in the connected device always take priority and are displayed. To display the images in the memory card first, disconnect the device from the USB A connector or change the setting in the [Select device] menu.
- **If multiple memory cards are inserted when the photo frame is turned on**, the images of the first memory card you inserted take priority and are displayed.
- **If multiple memory cards are inserted during the photo frame is turned off**, the priority order for display is as follows.
 - “Memory Stick” ➔ CompactFlash card
 - ➔ SD memory card/xD-Picture Card
- **If no memory card is inserted and no device is connected**, the images saved to the album in the internal memory are displayed.

Displaying images

■ Overview of display

You can press the buttons on the remote control to switch the display.*

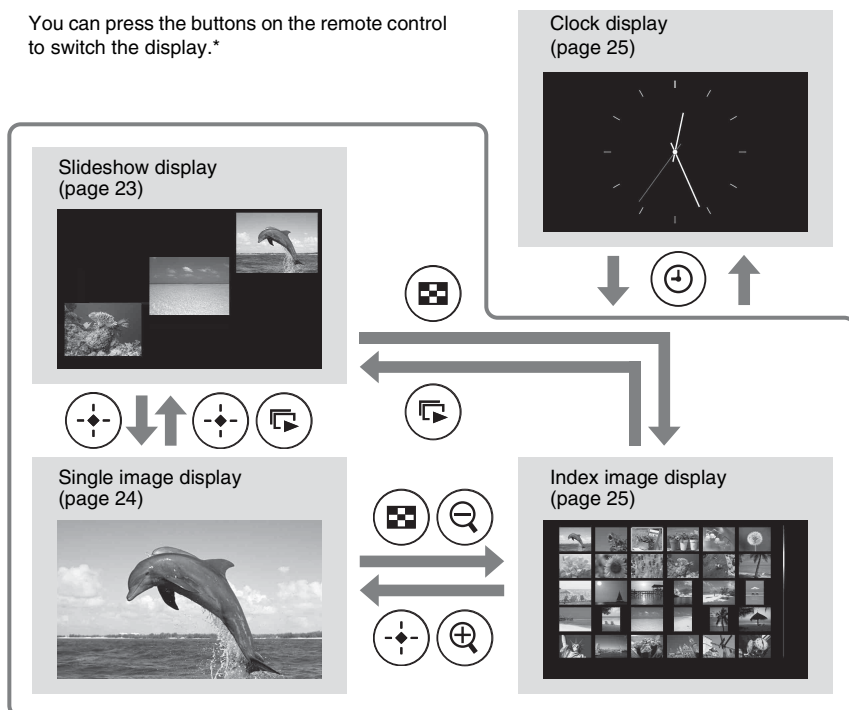

Tips*

- If the power is on and no memory card is inserted and no device is connected, the images in internal memory are displayed. If no images are saved to internal memory, demonstration mode starts automatically. Demonstration mode ends, if a memory card is inserted.
- The display mode stays unchanged once you turn the photo frame off and on again.

■ Slideshow display

Images in a memory card are automatically displayed one after another.

To start the slideshow

- To start a slideshow from single image, clock, or index image display, press  (slideshow).

Tip

To perform this operation from the photo frame, press  ENTER on the single image display mode.

There are several slideshow modes. Pressing VIEW MODE changes the modes in the following order.

Tip

You can set the interval on the single view and calendar view mode in the [Slideshow Settings] menu (page 34). On the single view mode, you can also set the effect and order in this menu.

Single view mode

Images are displayed in a single screen one after another with the effect selected in the [Slideshow Settings] menu.



Multiple image mode

Displays multiple images at same time.

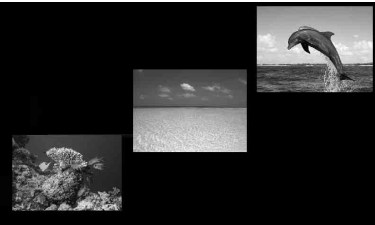

Clock view mode

Displays images with shooting date and time.

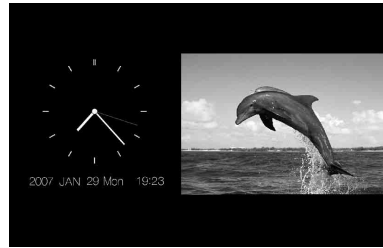

Calendar view mode

Displays images one after another while showing a calendar.



Random view mode

Displays images while randomly switching between the above four slideshow patterns.

■ Single image display

To display an image you want to display

- During a slideshow, press \odot at an image you want to display.
- In the index image display, press $\leftarrow/\rightarrow/\uparrow/\downarrow$ to select an image you want to display and then press \odot . You can also press Q (zoom in).

Tip

To perform this operation from the photo frame, press \leftarrow/\rightarrow ENTER at an image you want to display during a slideshow. In the index image display, press the direction buttons to select an image and then press \leftarrow/\rightarrow ENTER.

Pressing VIEW MODE changes the modes in the following order.

Tip

You can set the image display mode except image information mode with [Display Mode] in the [Various settings] menu (page 34). Not all images are able to be [Fit to screen].

Entire image mode

Displays an entire image in the screen.

You can switch the images to display by pressing \leftarrow/\rightarrow .



Fit to screen mode

Displays an image over the whole screen.

You can switch the images to display by pressing \leftarrow/\rightarrow .



Image information mode

Displays image information such as the image number, file name, and shooting date.

You can switch the images to display by pressing \leftarrow/\rightarrow .



The following information is displayed.

- Input/setting indications
Input indications and settings information for an image are displayed.

Icons	Meaning
	“Memory Stick” input
	SD Memory Card input
	CompactFlash input
	xD-Picture Card input
	External Device input
	Internal memory input
	Protect indication



Icons	Meaning
	Associated file indication (Displayed when there is an associated file such as a motion file or a miniature e-mail image file.)

- Image display order/Total number of images
- Image number (folder-file number)
This is displayed if the image is DCF compliant.
- Shooting date
- Image details
 - File format (JPEG, BMP, TIFF, RAW)
 - Number of pixels (width × height)
 - Manufacturer name of image input device
 - Model name of image input device
 - Shutter speed (e.g.: 1/8)
 - Aperture value (e.g.: F2.8)
 - Exposure value (e.g.: +0.0EV)

■ Index image display

The list of images in the selected memory card, internal memory or external device is displayed.

To show the index image display from a slideshow, clock, or single image display

Press  (index). You can also press  (zoom out) from the single image display.

Tip

To perform this operation from the photo frame, select the index image display in the menu on the single image display.

Press VIEW MODE to switch the modes of the index image display.

Small thumbnail mode

Displays a list of small thumbnails (5 rows × 6 columns).

You can select an image by pressing /↔/↕/↑.



Large thumbnail mode

Displays a list of large thumbnails (3 rows × 4 columns).

You can select an image by pressing /↔/↕/↑.



Notes

- In the index image display, images will not be automatically rotated when the photo frame is set to the portrait orientation.
- During TV output, the number of images displayed on the screen varies depending on your TV's screen size.

■ Clock display

Displays a clock or calendar. No image is displayed.

To display the clock display from slideshow, single image, or index image display

Press  (clock) on the remote control.

Tip

To perform this operation from the photo frame, select the clock display in the menu on the single image display.

Press VIEW MODE to switch the modes of the clock display.

Analog clock mode

Displays the time on analog clock.

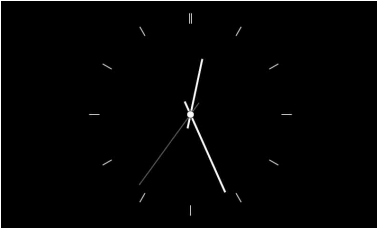

Digital clock mode

Displays the date and time on digital clock.



Calendar mode

Displays a calendar for the current month. You can press $\blacktriangledown/\blacktriangle$ to display a calendar for the previous or next month. You can also set the first day of the week for the calendar in the [Date/time settings] menu.



Tip

There are black and white background types for each of analogue clock, digital clock and calendar mode.

AUTO TOUCH-UP

What is AUTO TOUCH-UP?

AUTO TOUCH-UP is a feature for performing the following four corrections automatically at the same time. It is not possible to adjust the level for each of the corrections manually.

Skin smoothing: Automatically recognizes face parts, and adjusts the skin tone for a smoother look.

Backlight correction: Adjusts the brightness by using the face detect function.

Focus correction: Improves the focus of an out-of-focus image to create a better-focused image.

Red-eye correction: Automatically detects faces and corrects red-eye caused by the flash.

1 Display the image you want to correct as single image display.

2 Press MENU.
The menu is displayed.

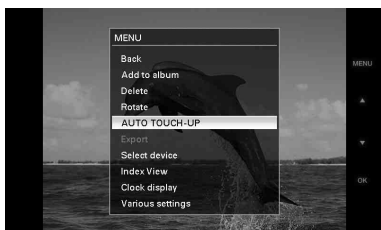

3 Press \downarrow/\uparrow to select [AUTO TOUCH-UP] and then press \odot .

Correction of the selected image begins and then the image before correction appears on the left and the corrected image appears on the right.

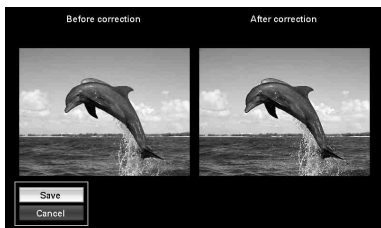

4 Press \downarrow/\uparrow to select [Save] and then press \odot .

The corrected image is saved as a new image.

To return to the original image (image before correction)

Select [Cancel] and then press \odot .

Tips

- The original image is the same as it was before correction.
- The corrected image is saved in the same device as the image before correction.
- To perform this operation from the photo frame, press MENU, press the direction buttons to select the item, and then press \rightarrow ENTER.

Notes

- Depending on the image, it may take a while for the correction.
- Depending on the image, the faces of people may not be able to be detected automatically.
- Depending on the image, focus correction may not be able to be performed properly. Focus correction is not effective for blurring caused by shaking of the camera.
- Depending on the image, red-eye correction may not be possible.



The automatic red-eye correction of this photo frame uses the technology of FotoNation Inc. in the U.S.A.

SILKYPIX®

The skin smoothing correction of the photo frame uses the technology of Ichikawa Soft Laboratory.

Specifying the playback device

You can specify the memory card or external device to be displayed.

- 1 Press MENU.
The menu is displayed.
- 2 Press \downarrow/\uparrow to select [Select device] and then press \odot .
The screen for selecting a device is displayed.

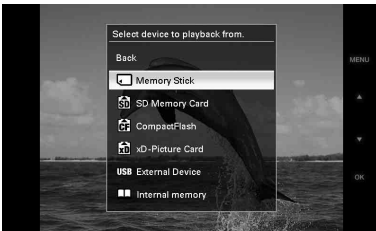

Tip

Insert the device at this procedure if no device is inserted.

- 3 Press \downarrow/\uparrow to select the device you want to display and then press \odot .
The images of the selected device are displayed.

Tip

To perform this operation from the photo frame, press MENU, press the direction buttons to select the device you want to display, and then press \odot ENTER.

Adjusting the image size and position

Enlarging an image

- 1 To enlarge an image, press \oplus (zoom in) on the remote control. To reduce an enlarged image, press \ominus (zoom out).
Each press of the \oplus button enlarges the image further. You can enlarge an image to maximum 5 times the original scale.
You can move an enlarged image up, down, left, and right.

Notes

- Enlarging an image may reduce the quality depending on the image size.
- It is not possible to enlarge an image with buttons on the photo frame.

Rotating an image

- 1 Press \odot (rotation) on the remote control.
Each press of the button rotates the image 90 degrees counter-clockwise.

To perform the operation from the menu of the remote control

- 1 Press MENU.
The menu is displayed.

- 2** Press $\blacktriangledown/\blacktriangle$ to select [Rotate] and then press \oplus .
The Rotate menu is displayed.



- 3** Press $\blacktriangledown/\blacktriangle$ to select the direction to rotate and then press \oplus .
- \curvearrowright :
Rotates the image 90 degrees clockwise.
 - \curvearrowleft :
Rotates the image 90 degrees counter-clockwise.

- 4** Press $\blacktriangledown/\blacktriangle$ to select [OK] and then press \oplus .

Tip

To perform this operation from the photo frame, press MENU, press the direction buttons to select the item, and then press \blacklozenge -ENTER.

Adding to the internal memory

You can use the photo frame as the digital album with saving important images in the internal memory.

Tip

In [Image file size] of the menu, you can preset whether to optimize the size of images or save images as is without compressing them when you save them to the internal memory.

- 1** Press Ⓜ (add to album) on the remote control.
The Add to album menu is displayed.

Single image display

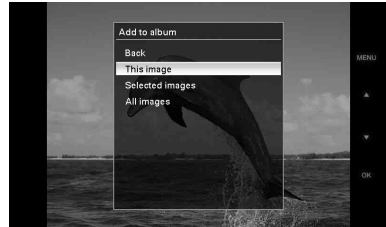

Slideshow display



Index image display

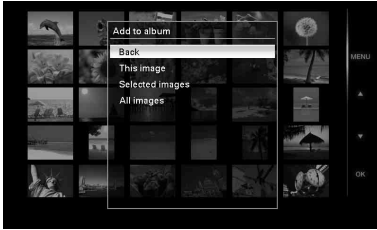

Tips

- To perform this operation from the menu, press MENU on remote control, press $\blacktriangledown/\blacktriangle$ to select [Add to album], and then press \oplus .
- Images in the internal memory cannot be added to the album.

2 Press $\blacktriangledown/\blacktriangle$ to select [This image], [Selected images] or [All images] and then press \oplus .

[This image]: Adds the image currently displayed*.

[Selected images]: Adds the selected images from the index display.

[All images]: Adds all images in the device displayed.

[Selected images] shows the images in the device which are currently displayed as index view.

If you select [This image] or [All images], go to step 4 to complete adding the image to the internal memory.

* You cannot select [This image] on the slideshow display.

3 If you selected [Selected images], choose the image you want to add.

① Press $\blacktriangleleft/\blacktriangleright/\blacktriangledown/\blacktriangle$ to select the image to add to the album and then press \oplus .
Check mark will be placed on each selected image.

Repeat this operation to add multiple images at the same time.



To cancel the selection, select images to cancel and then press \oplus to delete check mark.

② Press MENU.

The confirmation screen whether to save or not to the internal memory is displayed.

4 Press $\blacktriangledown/\blacktriangle$ to select [Yes] and then press \oplus .

The image is saved to the internal memory.

Exporting an image

You can export the images of the internal memory to a memory card or external device.

- 1 Press MENU.
The menu is displayed.
- 2 Press \downarrow/\uparrow to select [Export] and then press \oplus .
The Export menu is displayed.



- 3 Press \downarrow/\uparrow to select [This image], [Selected images] or [All images] and then press \oplus .
[This image]: Exports the image currently displayed or the image chosen at the index view.*

[Selected images]: Exports the selected image from the index display.

[All images]: Exports all images in the album.

Selecting [Selected images] shows the index display of images in the album.

If you select [This image] or [All images], go to step 5 to select the device to which you want to export.

* You cannot select [This image] on the slideshow display.

- 4 If you selected [Selected images], specify the image to export.
① Press $\leftarrow/\rightarrow/\downarrow/\uparrow$ to select the image you want to export and then press \oplus .
Check mark will be placed on each selected image.

Repeat this operation to export multiple images at the same time.

To cancel the selection, select images to cancel and then press \oplus to delete check mark.

- ② Press MENU.

The screen for selecting the device to which to export is displayed.

- 5 Press \downarrow/\uparrow to select the device to which to export the image and then press \oplus .

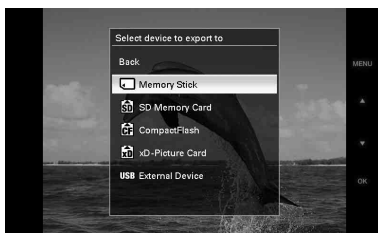

- 6 The confirmation screen is displayed after exporting is finished, and then press \oplus .
The image is copied to the specified device.

Note

Do not turn off the power or remove the memory card or disconnect the external device during exporting. Doing so may damage the photo frame or memory card, or damage the data.

Tip

To perform this operation from the photo frame, press MENU, press the direction buttons to select the item, and then press \leftarrow ENTER.

Deleting an image

- 1** Press MENU.
The menu is displayed.
- 2** Press \downarrow/\uparrow to select [Delete] and then press \oplus .
The Delete menu is displayed.
- 3** Press \downarrow/\uparrow to select [This image], [Selected images] or [All images] and then press \oplus .
[This image]: Deletes the image currently displayed.
[Selected images]: Deletes the selected image from the image list.
[All images]: Deletes all images in the device displayed.
[Selected images] shows the images in the device which are currently displayed as index view.
If you select [This image] or [All images], go to step 5 to confirm the operation.
- 4** If you selected [Selected images], specify the image to delete.
 - ①** Press $\leftarrow/\rightarrow/\downarrow/\uparrow$ to select the image to delete and then press \oplus . Check mark will be placed on each selected image.
Repeat this operation to delete multiple images at the same time.
To cancel the selection, select images to cancel and then press \oplus to delete check mark.
 - ②** Press MENU.
The delete confirmation screen is displayed.
- 5** Press \downarrow/\uparrow to select [Yes] and then press \oplus .
The image is deleted.

Tip

To perform this operation from the photo frame, press MENU, press the direction buttons to select the item, and then press \rightarrow ENTER.

Format of internal memory

When you use [Format internal memory] in [Various settings] menu, you can format the internal memory.

Changing the various settings

Setting procedure

You can change display, slideshow, brightness, language, and other settings of the photo frame. It is also possible to reset the settings to their factory defaults and format the internal memory.

Note

Only internal memory can be formatted.

- 1 Press MENU.
The menu is displayed.
- 2 Press \downarrow/\uparrow to select [Various settings] and then press \oplus to display the Various settings screen.



- 3 Press \downarrow/\uparrow to select the item you want to change and then press \oplus .
The setting screen of the selected item is displayed.



For example, when [Slideshow Settings] is selected.

- 4 Press \downarrow/\uparrow to select the item you want to change and then press \oplus . This enables you to set each of the items (page 34).

Note

When the photo frame is, for instance, displaying a slideshow, some items are unavailable for changing the settings. They are displayed in gray and cannot be selected.

- 5 Press \downarrow/\uparrow to select a setting value and then press \oplus .
Each time you press \downarrow/\uparrow (\downarrow/\uparrow from the photo frame), the setting value changes. In the case of a numerical value, press \uparrow to increase the value and press \downarrow to decrease the value.
If you press \oplus , the setting is confirmed.
- 6 Press MENU.
The menu closes.

Tips

- To perform this operation from the photo frame, press MENU, press the direction buttons to select the item, and then press \downarrow -ENTER.
- To reset the settings to their factory defaults, select [Reset] and then press \oplus . Adjusted values except clock setting are reset to default settings.

Items to set

*: Factory default settings

Item	Setting	Description	
Slideshow Settings	Interval	Set a value from 3 sec., 10 sec.*, 30 sec., 1 min., 5 min., 30 min., 1 hour, 3 hours, 12 hours, 24hours for the interval between images when the pattern is single view or calendar view.	
	Effect	Center cross	Transitions to the next image as though the previous image is being pushed from the center to the four corners.
		Vert. blinds	Transitions to the next image as though blinds are being lowered vertically.
		Horiz. blinds	Transitions to the next image as though blinds are being pulled horizontally.
		Fade*	Transitions to the next image by fading out the current image and fading in the next image.
		Wipe	Transitions to the next image as though the current image is being wiped off the screen to reveal the next image.
		Random	Uses the above five effects randomly.
	Order	Shoot. Date*	Displays images in the order of shooting date. Note When the number of images exceeds 1,500, the images cannot be displayed by date. The images are listed in the order of their file names.
		Random	Displays images randomly.
Screen Settings	LCD backlight	Allows you to set the brightness of the backlight of the LCD screen to a level from 1 to 10*.	
	Brightness	Allows you to set the luminance of images to a level from 1, 2*, 3. Note This function is not available when an image is displayed on TV with HDMI connection.	
		Display Mode	You can select the view mode for the single image display. Note The original image data will not change.
	Entire image*		Displays an image in the original horizontal to vertical ratio with margins on the top, bottom, left and right.
	Fit to screen		Zooms in at the center of the image enough to fill the whole screen.
	Auto image orientation	ON*/OFF: You can set the photo frame to automatically detect and rotate the orientation of images.	

Item	Setting	Description	
Screen Settings	Auto display orientation	ON*/OFF: When the photo frame is in portrait orientation, you can set it to automatically detect and rotate the images to their proper orientation.	
General Settings	Auto power ON/OFF	Power-ON timer	You can set the timer (hour/minute) for the power to turn on automatically. Select [ON] to set [Auto ON time].
		Power-OFF timer	You can set the timer (hour/minute) for the power to turn off automatically. Select [ON] to set [Auto OFF time].
	Image file size	Album*	Compresses images and saves them to the internal memory. You can save more images, but a deterioration in image quality compared to the original images is noticeable when the images are displayed on a large monitor via the HDMI OUT connector.
		Original	Saves images to the internal memory without compressing them. There is no deterioration, but you can save fewer images.
	Control for HDMI	ON*/OFF: Sets whether to enable or disable the HDMI control functions such as switching the TV's input automatically to its video mode so that the images are displayed, and operating the photo frame with the TV's remote control.	
Sony logo	ON*/OFF: You can set whether the photo frame's Sony logo lights or not.		
Date/time settings	Sets the date, time, first day of a week, etc. (➡ page 19)		
Language setting	Sets the display language on the LCD screen. Japanese, English*, French, Spanish, German, Italian, Russian, Chinese (Simplified), Chinese (Traditional), Dutch Note Default language setting may vary in some regions.		
Reset	Returns all settings to their factory defaults except for date/time setting.		
Format internal memory	You can format the internal memory. Notes <ul style="list-style-type: none"> • All the images added to the internal memory will be deleted. • Do not format the internal memory by using connection to PC or other external devices. 		
System Information	Version	Displays the version of the firmware of the photo frame.	
	Internal memory	Memory capacity	Indicates the maximum amount of space available in internal memory in the initial state.
		Remaining capacity	Indicates the amount of free space currently available in internal memory.

Connecting to a high definition TV to view images

Connecting to a high definition TV

The photo frame is capable of HDMI output. If you connect the photo frame to a TV with an HDMI input, you can display images in higher definition on the TV.

About “PhotoTV HD”

The photo frame supports “PhotoTV HD”. “PhotoTV HD” is a function for expressing subtle textures and color tones in high definition, giving the appearance of real photos. You can combine Sony devices that support “PhotoTV HD” together to enjoy photos at beautiful full HD quality. You can enjoy beautiful photo quality such as the subtle portrayal of skin or a flower petal and the textures of sand and waves on a large screen.

Note

Depending on the original images, high-definition display may not be possible.

- 1 Connect the photo frame to the AC power source. (→ page 17)
- 2 Prepare a commercially available HDMI cable.

Notes

- Use an HDMI cable that is less than 3 meters long.
- Use an HDMI cable with the HDMI logo.

- 3 Connect the HDMI OUT connector (A type connector) of the photo frame and the HDMI input connector of the TV.

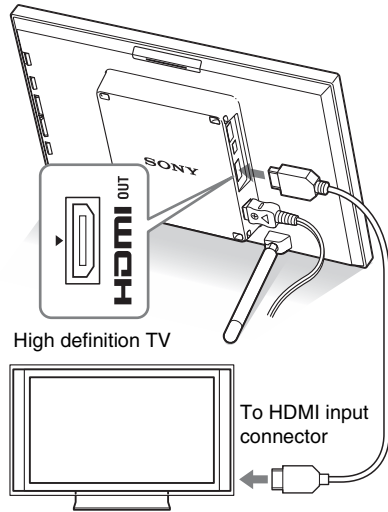

- 4 Press \odot (on/standby) on the photo frame to turn on the power.
- 5 Change the input of the TV. If the connected TV is compatible with HDMI control, the TV turns on automatically when you turn on the photo frame. Also, the input of the TV is changed automatically and images from the photo frame are displayed.





Notes

- Operation is not guaranteed with all TVs.
- If you connect a TV, the LCD screen of the photo frame turns off.
- If [Control for HDMI] is set to off in the TV settings, the input is not changed automatically. The setting method differs depending on the TV. Refer to the operating instructions supplied with the TV.
- If you are using a TV that does not support control for HDMI or the input is not switched automatically, change the TV's input manually.
- The method of changing the input differs depending on the TV. Refer to the operating instructions supplied with the TV.





Using the television remote control for photo frame

If your television supports the control for HDMI, you can use the remote control of your television to operate the photo frame.

Notes

- We cannot guarantee operations with all types of televisions.
- When a remote control of your Sony TV is equipped with a link menu button, you can use the remote control to operate the photo frame. Otherwise, you cannot use a TV remote control to operate the photo frame.
- To operate the photo frame, the    , [Enter], [Return] buttons support the HDMI control.
- If the HDMI control setting of your television is off, the television input does not switch automatically. Settings differ depending on the television you use. For details, see the manual supplied with your television.
- If [Control for HDMI] is set to [OFF], the input will not switch automatically (page 35).

■ Basic operations of the photo frame with a TV remote control

- Press    , [Enter] on the TV remote control to select the images on the single image display.
- Press [Enter] button on the TV remote control to switch the single image display and the slideshow display.

Note

With the TV remote control, you cannot do the following operation:

- Changing the VIEW MODE.
- Setting the MENU function.
- Zooming in/Zooming out

On control for HDMI

When the [Control for HDMI] is set to [ON], you can use the following operations:

- Turning off the photo frame power together with the television.
- After the photo frame is connected to the TV, you can switch the TV input automatically to the photo frame by turning

on the photo frame, or by connecting the powered-on photo frame to the television. If a television is on the standby mode, the television is also turned on.

- You can perform the photo frame operations using the TV remote control unit.
- If you switch the language of the TV while the photo frame and the television is being connected, you can also change the photo frame language automatically.

Note

To enable above functions, your television must support each function.

What is “BRAVIA Sync”

The “BRAVIA Sync” is a name of a feature of Sony products that uses the HDMI control signals and enables you to control linked operations of a “BRAVIA Sync”-ready product from a BRAVIA control unit.

By connecting the photo frame and a “BRAVIA Sync”-compatible TV with an HDMI cable, you can use a BRAVIA control unit to perform linked operations.

Using a Bluetooth device

You can connect a Bluetooth adaptor (optional) to the USB A connector of the photo frame and transfer images from a Bluetooth compatible mobile phone or other device. The transferred images are saved to internal memory.

- 1 Connect the photo frame to the AC power source. (→ page 17)
- 2 Press  (on/standby) on the photo frame to turn on the power.
- 3 Connect the Bluetooth adaptor (optional) to the USB A connector.
- 4 Transfer the images to the photo frame by performing operations from the mobile phone.

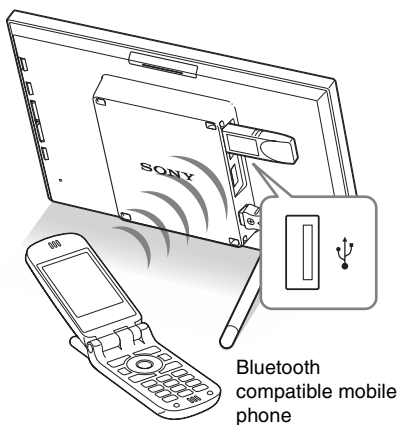

Transferring images from an external device

You can connect a digital camera, USB memory, or photo storage with support for mass storage to the photo frame and transfer images.

Notes

- Compatibility with all external devices is not guaranteed.
- If an external device is connected to the USB A connector on the photo frame, the photo frame cannot read the images in card media. Disconnect an external device, if you need.

- 1 Connect the photo frame to the AC power source. (→ page 17)
- 2 Set the digital camera or external device to mass storage connection mode.
The setting and operation method before connecting differ depending on the digital camera or external device. Refer to the operating instructions supplied with the digital camera or external device. (If you are using a Cyber-shot, set "USB Connect" to [Normal] or [Mass Storage].)
- 3 Press  (on/standby) on the photo frame to turn on the power.
- 4 Connect the digital camera or external device to the USB A connector.
Use the USB cable supplied with the digital camera or external device to connect to the photo frame.

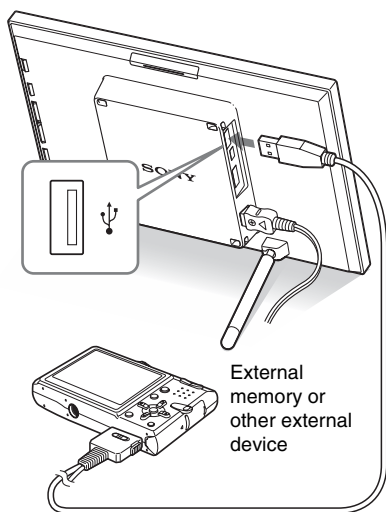

External memory or other external device

Notes

- When using a commercially available USB cable, use an A-Type USB cable that is less than 3 meters long.
- Do not disconnect the USB cable or turn the photo frame and external device off while the access lamp on the external device is flashing. Doing so may damage the data in the external device. Sony assumes no responsibility for any damage or loss of data.
- A USB hub or USB device with a built-in USB hub may not work properly.
- The photo frame cannot use data that has been encrypted or compressed using, for instance, fingerprint authentication or a password.

Connecting to a computer

You can connect to a computer to view and copy images of the internal memory of the photo frame to the computer, and copy images of the computer to the photo frame.

System requirements

To connect a computer to use the picture frame, your computer must satisfy the following recommended system requirements.

■ Windows

Recommended OS: Microsoft Windows Vista, Windows XP Service Pack 2 or Windows 2000 Professional Service Pack 4

(pre-installed at the time of shipment from the factory)

Port: USB port

■ Macintosh

Recommended OS: Mac OS X (10.4) or later (pre-installed at the time of shipment from the factory)

Port: USB port

Notes

- If multiple USB devices are connected to a computer or if a hub is used, a problem may occur. In such a case, simplify the connections.
- You cannot operate the photo frame from another USB device being used simultaneously.
- Do not disconnect the USB cable during data communication.
- Operation with all computers that satisfy the recommended system requirements is not guaranteed.
- The photo frame has been demonstrated as operable with connecting to PC or Sony digital photo printer. When other devices are connected to the photo frame, these devices may not recognize the internal memory of the photo frame.

Connecting to a computer to exchange images

- 1 Connect the photo frame to the AC power source. (→ page 17)
- 2 Connect the computer and photo frame with a commercially available USB cable (optional: VMC-14UMB2)*.

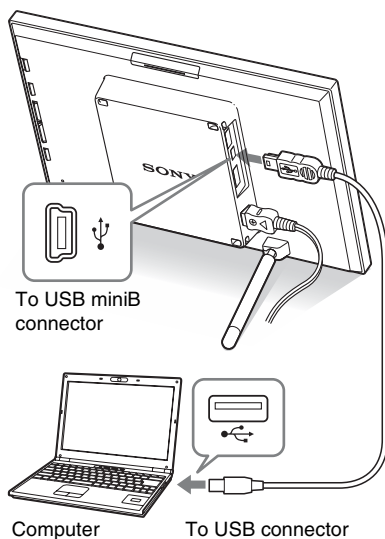

* This cable may not be available in all countries.

Note

Use a mini B-Type USB cable that is less than 3 meters long.

- 3 Press  (on/standby) on the photo frame to turn on the power.
- 4 Exchange images with the internal memory of the photo frame by performing operations from the computer.

Note

When images of the computer are saved to the internal memory of the photo frame, the image files are saved without being compressed. As a result, fewer images may be able to be saved to the internal memory of the photo frame.

If an error message appears

If an error occurs, one of the following error messages may be displayed on the LCD screen of the photo frame. Follow the corresponding solution below to solve the problem.

Error message	Meaning/Solutions
No Memory Stick. / No CompactFlash card. / No SD Memory Card. / No xD-Picture Card. / No External Device.	<ul style="list-style-type: none">• A memory card is not inserted in a slot. Or, an external device is not connected to the A-Type USB connector. Insert a memory card in the corresponding slot. Or, connect an external device. (➡ pages 20, 38)
An incompatible Memory Stick is inserted. / An incompatible CompactFlash card is inserted. / An incompatible SD Memory Card is inserted. / An incompatible xD-Picture Card is inserted. / An incompatible External Device is inserted.	<ul style="list-style-type: none">• An unsupported memory card is inserted. An unsupported external device is connected to the A-Type USB connector. Use a memory card or external device that is supported by the photo frame.
No images on file.	<ul style="list-style-type: none">• There are no image files in the memory card or external device. Use a memory card or external device containing image files that can be displayed with the photo frame.
Cannot delete a protected image.	<ul style="list-style-type: none">• To delete a protected file, cancel the protection on your digital camera.
Media is protected. Remove protection then try again.	<ul style="list-style-type: none">• The memory card is write-protected. Slide the write-protect switch to the enable position. (➡ page 49)
The Memory Stick is full. / The CompactFlash card is full. / The SD Memory Card is full. / The xD-Picture Card is full. / The External Device is full.	<ul style="list-style-type: none">• No more data can be saved because the memory card or external device is full. Delete images, or use a memory card or external device with free space.
Error reading the Memory Stick. / Error reading the CompactFlash card. / Error reading the SD Memory Card. / Error reading the xD-Picture Card. / Error reading the External Device.	<ul style="list-style-type: none">• An error has occurred. If this error message is displayed frequently, check the status of the memory card or external device with a device other than the photo frame.• In the case of an external device: The external device may be write-protected. Cancel the write-protection setting for the device you are using. The internal memory of a digital camera may be write-protected.
Write error in the Memory Stick. / Write error in the CompactFlash card. / Write error in the SD Memory Card. / Write error in the xD-Picture Card. / Write error in the External Device.	
The Memory Stick is read only.	<ul style="list-style-type: none">• A “Memory Stick-ROM” is inserted. To save the images, use the “Memory Stick” recommended (➡ page 48).

Error message	Meaning/Solutions
The Memory Stick is protected.	<ul style="list-style-type: none"> <li data-bbox="460 153 1018 207">• A protected “Memory Stick” is inserted. To edit and save the images, use an external device to remove protection.
Media format not supported. Cannot open the image.	<ul style="list-style-type: none"> <li data-bbox="460 217 1018 271">• The images cannot be displayed, if the image file is not supported by the photo frame.
No more USB hubs can be connected.	<ul style="list-style-type: none"> <li data-bbox="460 288 1018 343">• Connect the device directly to the photo frame, or use a device without a built-in USB hub.
Incompatible USB device. Check device’s USB settings.	<ul style="list-style-type: none"> <li data-bbox="460 352 1018 429">• Connect the device with support for mass storage. If USB setting of your device is incorrect, set the mass storage mode in USB setting.

If trouble occurs

Before submitting the photo frame for repair, try using the following guidance to solve the problem. If the problem persists, consult with your Sony dealer or Sony service facilities.



Power supply

Symptom	Check item	Cause/Solutions
The power cannot be turned on.	<ul style="list-style-type: none">Is the power plug inserted properly?	→ Insert the power plug properly.

Displaying images

If the power is turned on but images are not displayed or the settings of the operation screen cannot be configured, confirm the following check items.

Symptom	Check item	Cause/Solutions
No images are displayed on the screen.	<ul style="list-style-type: none">Is a memory card inserted or an external device connected properly?	→ Insert a memory card or connect an external device properly. (→ pages 20, 38)
	<ul style="list-style-type: none">Does the memory card contain images saved with a digital camera or other device?Are images stored on the external device?	→ Insert a memory card containing images or connect an external device containing images. → Check the file formats that can be displayed. (→ page 51)
	<ul style="list-style-type: none">Is the file format compatible with the DCF?	→ A file that is not compatible with DCF may not be able to be displayed with the photo frame, even if it can be displayed with a computer.

Symptom	Check item	Cause/Solutions
Some images are not displayed.	<ul style="list-style-type: none"> Are the images displayed in the index view? 	<ul style="list-style-type: none"> → If the image is displayed in the index view but cannot be displayed as single image, the image file may be damaged even though its thumbnail preview data is fine. → A file that is not compatible with DCF may not be able to be displayed with the photo frame, even if it can be displayed with a computer.
	<ul style="list-style-type: none"> Does the mark displayed below appear in the index view? 	<ul style="list-style-type: none"> → If the mark shown on the left is displayed, the image file may not be supported by the photo frame because, for example, it is a JPEG file that was created with your computer. Also, the image file may be supported, but not contain the thumbnail data. Select the mark and press (⊕) to change the screen to the single image display. If the mark on the left is displayed again, the image cannot be displayed because the image file is not supported by the photo frame.
	<ul style="list-style-type: none"> Were the images created with an application on a computer? 	
	<ul style="list-style-type: none"> Does the mark displayed below appear in the index view? 	<ul style="list-style-type: none"> → If the mark shown on the left is displayed, the image file is supported by the photo frame, but the thumbnail data or image itself cannot be opened. Select the mark and press (⊕). If the mark shown on the left is displayed again, the image cannot be displayed.
	<ul style="list-style-type: none"> Are there more than 9,999 images in the memory card or external device? 	<ul style="list-style-type: none"> → The photo frame can play, save, delete, or otherwise handle up to 9,999 image files.
	<ul style="list-style-type: none"> Did you rename the file with a computer or other device? 	<ul style="list-style-type: none"> → If you named or renamed the file on your computer and the file name includes characters other than alphanumeric characters, the image may not be able to be displayed on the photo frame.
	<ul style="list-style-type: none"> Are there eight or more levels in the folder hierarchy of the memory card or external device? 	<ul style="list-style-type: none"> → The photo frame cannot display images saved in a folder that is more over eight levels deep.

Symptom	Check item	Cause/Solutions
The file name is not displayed properly.	<ul style="list-style-type: none"> • Did you rename the file with a computer or other device? 	<p>→ If you named or renamed the file on your computer and the file name includes characters other than alphanumeric characters, the file name may not be able to be displayed properly on the photo frame. Also, for a file created on a computer or other device, a maximum of eight characters from the beginning of the file name can be displayed.</p> <p>Note Only alphanumeric characters can be displayed.</p>
Blank areas appear at the top and bottom.	<ul style="list-style-type: none"> • Is the image extremely high or wide? 	<p>→ If an image is extremely high or wide, blank areas may appear because of the ratio between the height and width.</p>

Saving and deleting images

Symptom	Check item	Cause/Solutions
Cannot save an image.	<ul style="list-style-type: none"> • Is the memory card write-protected? 	<p>→ Cancel write-protection and try saving again.</p>
	<ul style="list-style-type: none"> • Is the write-protect switch of the memory card in the [LOCK] position? 	<p>→ Slide the write-protect switch to the enable position. (→ page 49)</p>
	<ul style="list-style-type: none"> • Is the memory card full? 	<p>→ Replace the memory card with one with sufficient free space. Or, delete any unnecessary images. (→ page 32)</p>
	<ul style="list-style-type: none"> • Is the internal memory full? 	<p>→ Delete any unnecessary images. (→ page 32)</p>
Cannot delete an image.	<ul style="list-style-type: none"> • Is the memory card write-protected? 	<p>→ Use the device you are using to cancel write-protection and try deleting again.</p>
	<ul style="list-style-type: none"> • Is the write-protect switch of the memory card in the [LOCK] position? 	<p>→ Slide the write-protect switch to the enable position. (→ page 49)</p>
	<ul style="list-style-type: none"> • Are you using “Memory Stick-ROM”? 	<p>→ It is not possible to delete an image from or format “Memory Stick-ROM”.</p>
An image was deleted accidentally.	—	<p>→ An image cannot be recovered once it is deleted.</p>

Connecting a digital camera or other external device

Symptom	Check item	Cause/Solutions
The camera is connected but nothing is displayed.	• Is the cable connected properly?	→ Connect the cable properly.
	• Is the photo frame turned on?	→ Turn the photo frame on.
Nothing happens even if the USB cable is disconnected and then connected.	—	→ An over current error may have occurred with the photo frame. To recover from the error, turn the power of the photo frame off and then back on.
Images are not displayed on the TV screen or LCD screen.	• The input of the TV is set to the external input.	→ Even if the input of the TV is not set to the photo frame, images may sometimes not be displayed on the TV screen or LCD screen if an HDMI cable is connected. → Change the input of the TV to the photo frame, or disconnect the HDMI cable and switch the display to the LCD screen.

Photo frame

Symptom	Check item	Cause/Solutions
Nothing happens even if you operate the photo frame.	—	→ Push reset switch on rear side of the photo frame by thin object such as a pin, etc.

Precautions

On safety

- Be careful not to set or drop any heavy objects on the power cord, or to damage the power cord in any way. Never operate this photo frame with a damaged power cord.
- Should any solid object or liquid fall into the cabinet, unplug the photo frame and have it checked by qualified personnel before operating it any further.
- Never disassemble the photo frame.
- To disconnect the power cord, pull it out by the plug. Never pull the power cord itself.
- When the photo frame is not going to be used for an extended period of time, disconnect the power cord from the wall outlet.
- Do not handle the photo frame roughly.
- To reduce the risk of electrical shock, always unplug the photo frame from the electrical outlet before cleaning and servicing the photo frame.

On installation

- Avoid placing the photo frame in a location subject to:
 - vibration
 - humidity
 - excessive dust
 - direct sunlight
 - extremely high or low temperatures
- Do not use electrical equipment near the photo frame. The photo frame will not work properly in electromagnetic fields.
- Do not place heavy objects on the photo frame.

On the AC adaptor

- Even if your photo frame is turned off, AC power (house current) is still supplied to it

while connected to the wall outlet via the AC adaptor.

- Be sure to use the AC adaptor supplied with the photo frame. Do not use other AC adaptors, as this may cause a malfunction.
- Do not use the supplied AC adaptor for other devices.
- Do not use an electrical transformer (travel converter), as this may cause overheating or a malfunction.
- In case the cord of the AC adaptor is damaged, do not use it any longer, as this may be dangerous.

On moisture condensation

If the photo frame is brought directly from a cold location to a warm location or placed in an extremely warm or humid room, moisture may condense inside the unit. In such cases the photo frame will probably not work properly and may even develop a fault if you persist in using it. If moisture condensation occurs, unplug the AC power cord of the photo frame and do not use the photo frame for at least one hour.

On transport

When you transport the photo frame, remove the memory card, external devices, AC adaptor and connected cables from the photo frame and put the photo frame and its peripherals in the original box with the protective packaging.

If you no longer have the original box and packing parts, use similar packing material so that the photo frame will not be damaged while being transported.

On cleaning

Clean the photo frame with a soft dry cloth, or a soft cloth lightly moistened with a mild detergent solution. Do not use any type of solvent, such as alcohol or benzine, which may damage the finish.

On restrictions on duplication

TV programs, films, video tapes, portraits of other people or other materials may be copyrighted. Unauthorized use of such materials may infringe the provisions of the copyright law.

About the memory cards

“Memory Stick”

Types of “Memory Stick” that the photo frame can use

With the photo frame, you can use the following types of “Memory Stick”^{*1}:

Type of “Memory Stick”	Displaying	Deleting/ Saving
“Memory Stick” ^{*2} (Not compatible with “MagicGate”)	OK	OK
“Memory Stick” ^{*2} (Compatible with “MagicGate”)	OK ^{*5}	OK ^{*5}
“MagicGate Memory Stick” ^{*2}	OK ^{*5}	OK ^{*5}
“Memory Stick PRO” ^{*2}	OK ^{*5}	OK ^{*5}
“Memory Stick PRO-HG” ^{*2}	OK ^{*5*6}	OK ^{*5*6}
“Memory Stick Micro” ^{*3} (“M2” ^{*4})	OK ^{*5}	OK ^{*5}

^{*1} The photo frame supports FAT32. The photo frame has been demonstrated as operable with a “Memory Stick” with a capacity of 8GB or less manufactured by Sony Corporation. However, we do not guarantee the operations of all the “Memory Stick” media.

^{*2} The photo frame is equipped with a slot compatible with both standard-size and Duo-size media. Without a “Memory Stick Duo” adaptor, you can use both a standard-size “Memory Stick” and the compact-size “Memory Stick Duo”.

^{*3} When using a “Memory Stick Micro” with the photo frame, always insert it into an M2 adaptor.

^{*4} “M2” is an abbreviation for “Memory Stick Micro”. In this section, “M2” is used to describe “Memory Stick Micro”.

^{*5} Data reading/recording that requires “MagicGate” copyright protection cannot be performed. “MagicGate” is the general name of a copyright

protection technology developed by Sony using authentication and encryption.

⁶ The photo frame does not support 8 bit parallel data transfer.

Notes on use

- For the latest information on the “Memory Stick” types that the photo frame supports, see the “Memory Stick” compatibility information on the Sony web site: <http://www.memorystick.com/en/support/support.html> (Select the area where you use your photo frame, and then select “Digital Photo Frame” from each area page.)
- Do not insert more than one “Memory Stick” at the same time, which may cause trouble with the photo frame.
- If you use a “Memory Stick Micro” with the photo frame, “Memory Stick Micro” needs to be inserted into an “M2” adaptor.
- If you insert a “Memory Stick Micro” into the photo frame without an “M2” adaptor, you may be unable to remove the “Memory Stick Micro”.
- If you insert a “Memory Stick Micro” into an “M2” adaptor, and insert the “M2” adaptor into a “Memory Stick Duo” adaptor, the photo frame may not operate properly.
- When you format a “Memory Stick”, use the format function of your digital camera. If you format a “Memory Stick” with your computer, images may not be displayed properly.
- When you format a “Memory Stick”, all the data including protected image files will be erased. To avoid erasing important data by accident, make sure to check the contents of the “Memory Stick” before formatting.

- You cannot record, edit or delete data if you slide the write-protect switch to LOCK.

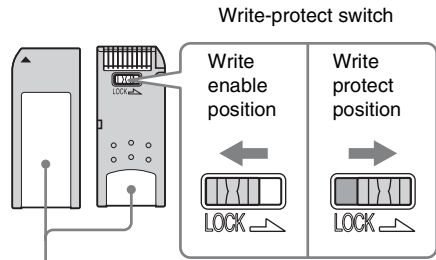

Place the label here.

- Do not attach any other material than the supplied label on the labelling position. When you attach the supplied label, be sure to attach it to the labelling position. Be careful that the label does not stick out.

SD memory card

The SD memory card slot of the photo frame allows you to use the following:

- SD memory card^{*1}
- miniSD card, microSD card (An adaptor is necessary.)^{*2}
- SDHC memory card^{*3}
- MMC standard memory card^{*4}

We do not guarantee proper operations for all types of SD memory cards and MMC standard memory cards.

^{*1} The photo frame has been demonstrated as operable with an SD memory card with a capacity of 2 GB or smaller.

^{*2} Some commercially available card adaptors have projected terminals on the rear. This type of adaptor may not work properly with the photo frame.

^{*3} The photo frame has been demonstrated as operable with an SDHC memory card with a capacity of 8 GB or less.

^{*4} The photo frame has been demonstrated as operable with an MMC standard memory card with a capacity of 2 GB or less.

Notes on use

Data reading/recording that requires copyright protection cannot be performed.

xD-Picture Card

With the xD-Picture Card slot of the photo frame, you can use an xD-Picture Card^{*5}. Not all the memory card operations are supported and we do not guarantee proper operations for all types of xD-Picture Card.

^{*5} The photo frame has been demonstrated as operable with an xD-Picture Card with a capacity of 2 GB or less.

CompactFlash card

The CompactFlash card slot of the photo frame allows you to use the following:

- CompactFlash Memory Card (Type I/Type II) and CF+Card (Type I/Type II)-compatible CompactFlash Card^{*6}
- Microdrive

You can also use the Smart Media card by using a commercially available CompactFlash card adaptor^{*7}.

However, we do not guarantee proper operations for all types of CompactFlash cards.

^{*6} Use a CompactFlash card with a power specification of 3.3V or 3.3V/5V. You cannot use a type for 3V or 5V only. Do not insert other types of CompactFlash card into the photo frame's insertion slot. The photo frame may be damaged. The photo frame has been demonstrated as operable with a CompactFlash with a capacity of 8 GB or smaller.

^{*7} When using a commercially available CompactFlash card adaptor, refer to the operating instructions of the adaptor you use for how to install the card and adaptor. When using the CompactFlash card adaptor, the write-protected card may not work properly.

Notes on using a memory card

- When using a card, make sure to check the correct insertion direction of the card and the correct insertion slot.
- When inserting the memory card, it will only insert the portion of the way, so do not try to force it as this could damage the memory card and/or photo frame.
- Do not remove a card or turn off the photo frame while the photo frame is reading or writing data, or the access indicator is flashing. Otherwise, data may be rendered unreadable or erased.
- We recommend that you save a backup of important data.
- Data processed with the computer may not be displayed with the photo frame.
- When you carry or store a card, put it in the case supplied with it.
- Do not touch the terminal of a card with your hand or a metal object.
- Do not strike, bends or drop a card.
- Do not disassemble or modify a card.
- Do not expose a card to water.
- Do not use or store a card under the following conditions:
 - Locations beyond the required operational conditions including locations such as the hot interior of a car parked in the sun and/or in the summer, the outdoors exposed to direct sunlight, or a place near a heater.
 - Humid locations or locations with corrosive substances present
 - Locations subject to static electricity or electrical noises

Specifications

■ Photo frame

LCD screen

LCD panel:

DPF-V900: 9 inches, TFT active matrix

DPF-V700: 7 inches, TFT active matrix

Total number of dots:

DPF-V900: 1 080 000

(750 × 3 (RGB) × 480) dots

DPF-V700: 1 152 000

(800 × 3 (RGB) × 480) dots

Display aspect ratio

15:9

Effective display area

DPF-V900: 8.6 inches

DPF-V700: 7 inches

LCD backlight life

DPF-V900: 15 000 hours

DPF-V700: 20 000 hours

(before brightness of the backlight being reduced to half)

Maximum decodable file size

100 MB

Input/Output connectors

HDMI OUT (output) connector

A-TYPE connector,

1 080i (60Hz)/1 080i (50Hz)/

720p (60Hz)/720p (50Hz)/

576p (50Hz)/480p (60Hz) compatible,

BRAVIA Sync compatible

USB connector (miniB, full-speed)

Bluetooth/USB A connector

(Type A, full-speed)

Slots

“Memory Stick PRO” slot

SD memory card/MMC/

xD-Picture Card slot

CompactFlash card/Microdrive slot

Compatible image file formats

JPEG: DCF 2.0 compatible, Exif 2.21 compatible, JFIF^{*1}

TIFF: Exif 2.21 compatible

BMP: 1, 4, 8, 16, 24, 32 bit Windows format

RAW (preview only^{*2}): SRF, SR2, ARW (2.0 or lower version)

(Some image file formats are not compatible.)

Maximum number of pixels that can be displayed

8 000 (H) × 6 000 (V) pixels

File system

FAT12/16/32,

sector size of 2 048 bytes or smaller

Image file name

DCF format, 256 characters, within 8th hierarchy

Maximum number of files that can be handled

9 999 files for a memory card/an external device

Internal memory capacity^{*3}

512 MB (Approx. 1 000 images^{*4} can be saved.)

Power requirements

DC IN jack, DC 8.4V

Power consumption

DPF-V900: 12 W

DPF-V700: 8 W

Operating temperature

5 °C to 35 °C (41 °F to 95 °F)

Storage temperature

−20 °C to 60 °C (−4 °F to 140 °F)

Dimensions

[Without the stand]

DPF-V900:

Approx. 245 × 162 × 38.5 mm

(9 ³/₄ × 6 ¹/₂ × 1 ⁹/₁₆ inches)

DPF-V700:

Approx. 207 × 137 × 38.5 mm

(8 ¹/₄ × 5 ¹/₂ × 1 ⁹/₁₆ inches)

(width/height/depth)

[With the stand spread out]

DPF-V900:

Approx. 245 × 162 × 145 mm

(9 ³/₄ × 6 ¹/₂ × 5 ³/₄ inches)

DPF-V700:

Approx. 207 × 137 × 125 mm
(8 1/4 × 5 1/2 × 5 inches)
(width/height/depth)

Mass

DPF-V900: Approx. 800 g (1 lb 12 oz)
DPF-V700: Approx. 550 g (1 lb 3 oz)
(excluding the AC adaptor)

Included accessories

See “Checking included items” on
page 13.

■ AC adaptor AC-L200

Power requirements

~ 100 V to 240 V, 50/60 Hz

Power consumption

18 W

Rated output voltage

== 8.4 V

Dimensions

Approx. 48 × 29 × 81 mm
(1 15/16 × 1 3/16 × 3 1/4 inches)
(width/height/depth)
(excluding the protruding parts)

Mass

Approx. 170 g (6 oz)

See the label of AC adaptor for more details.

Design and specifications are subject to change
without notice.

- *1: Baseline JPEG with 4:4:4, 4:2:2, or 4:2:0 format
- *2: RAW files are displayed as thumbnail preview.
- *3: The capacity is calculated as 1 MB is equivalent to 1 000 000 bytes. The actual capacity is reduced as files for management and applications are included. Approx. 400 MB can be used for your actual operation.
- *4: Approximate number is shown when the images taken by 2 000 000 pixels equivalent camera are saved. The value may vary depending on the shooting condition.

Customer support home page

The latest support information is available at the
following home page address:

<http://www.sony.net/>

Index

A

- AC adaptor 17
- Accessories 13
- Adding to the internal memory 29
- Auto display orientation 35
- Auto image orientation 34
- Auto power ON/OFF 35
- AUTO TOUCH-UP 27

C

- Changing the settings 33
- Cleaning 47
- Clock display 25
 - Analog clock mode 26
 - Calendar mode 26
 - Digital clock mode 26
- Connecting
 - Computer 39
 - External device 38
 - TV 36

- Connecting to the AC power source 17
- Control for HDMI 35

D

- Date/time settings 19, 35
- DC IN 8.4 V 17
- Deleting an image 32
- Display Mode 34
- Display priority 21
- Displaying images 22

E

- Error messages 41
- Exporting an image 31

F

- Features 12
- Format internal memory 35

H

- HDMI OUT 36
- High definition TV 36

I

- Image file size 35
- Index image display 25
- Inserting a memory card 20

L

- Language setting 35

M

- Mass storage compatible devices 38
- Memory cards 48
 - CompactFlash card 50
 - Memory Stick 48
 - Notes on use 50
 - SD memory card 49
 - xD-Picture Card 50

P

- Placing in portrait or landscape orientation 18
- Playback device 28
- Precautions 47

R

- Remote control 16
- Replacing the battery of the remote control 16
- Reset 35
- Rotating an image 28

S

- Screen Settings 34
- Setting the clock 19
- Setting the stand 18

- Single image display 24
 - Entire image mode 24
 - Fit to screen mode 24
 - Image information mode 24

Slideshow 23

- Calendar view mode 23
- Clock view mode 23
- Effect 34
- Interval 34
- Multiple image mode 23
- Order 34
- Random view mode 23
- Single view mode 23

Slideshow Settings 34

- Specifications 51
- System Information 35
- System requirements
 - Macintosh 39
 - Windows 39

T

- Troubleshooting 43

U

- USB A connector 38
- USB cable 38

W

- Write-protect switch 49

Z

- Zooming in/out an image 28



Printed using VOC (Volatile
Organic Compound)-free
vegetable oil based ink.